

SCHOTTKY BARRIER RECTIFIERS

FEATURES

- High breakdown voltage
- Low turn-on voltage
- Guard ring construction for transient protection

MECHANICAL DATA

- Case: SOD-123
- Terminals: Solderable per MIL-STD-750, Method 2026
- Approx. Weight: 16mg/0.00056oz

PINNING

PIN	DESCRIPTION
1	Cathode
2	Anode

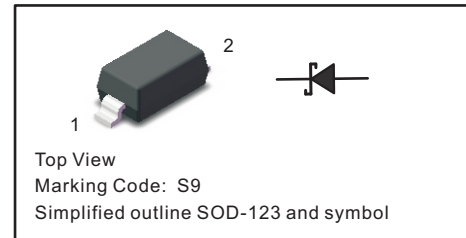

Maximum Ratings at 25 °C

Parameter	Symbols	BAT46W	Units
Maximum Repetitive Peak Reverse Voltage	V_{RRM}	100	V
Working peak reverse voltage	V_{RWM}	100	V
Continuous Forward Current	I_F	150	mA
Repetitive peak forward current (Note 1) @ $t_p < 1.0s$, Duty Cycle $< 50\%$	I_{FRM}	350	mA
Non-repetitive Peak Forward Surge Current at 8.3ms	I_{FSM}	25	A
Power Dissipation	P_D	200	mW
Thermal resistance junction to ambient air	R_{thJA}	500	°C/W
Operating and Storage Temperature Range	T_j, T_{stg}	-55 ~ +125	°C

ELECTRICAL CHARACTERISTICS (Ta=25°C unless otherwise specified)

Parameter	Symbols	BAT46W	Units
Reverse Breakdown Voltage at $I_R=100\mu A$ (NOTE 2)	$V_{(BR)R}$	100	V
Maximum Forward Voltage (NOTE 2) $I_{F1}=10\text{ mA}$ $I_{F2}=250\text{ mA}$	V_F	0.45 1.0	V
Peak Reverse Current $V_{R1}=1.5V$ $V_{R2}=10V$ $V_{R3}=50V$ $V_{R4}=75V$	I_R	0.3 0.5 1 2	μA
Diodes Capacitance $V_R=0, f=1\text{MHz}$ $V_R=1V, f=1\text{MHz}$	C_T	20 12	pF

NOTES:

- (1) Part mounted on FR-4 board with recommended pad layout.
- (2) Short duration pulse test used to minimize self-heating effect.

Fig.1 Power Derating Curve

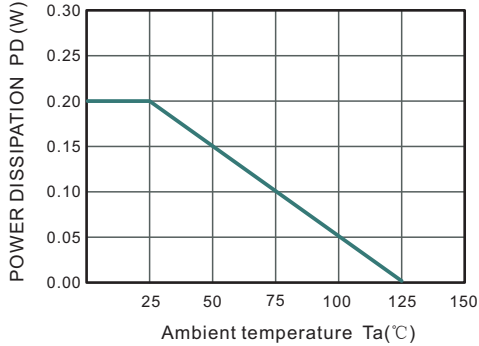

Fig.2 Typical Reverse Characteristics

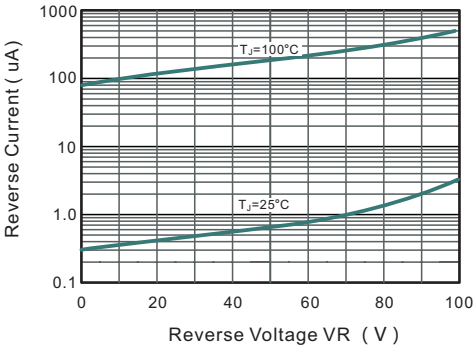

Fig.2 TYPICAL FORWARD VOLTAGE

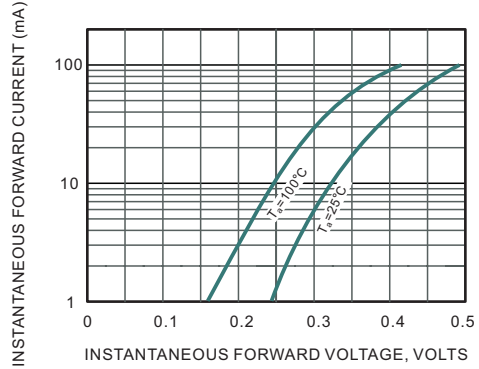

Fig.3 Typical Junction Capacitance

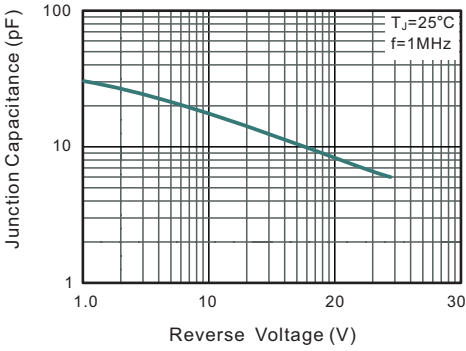

Fig.5 Maximum Non-Repetitive Peak Forward Surge Current

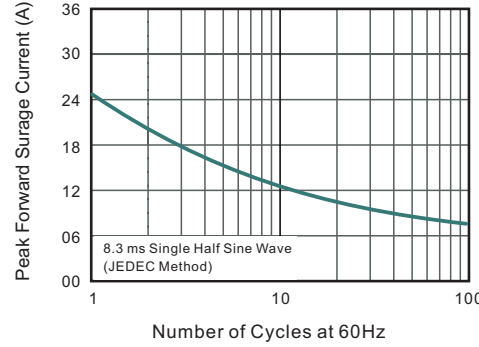
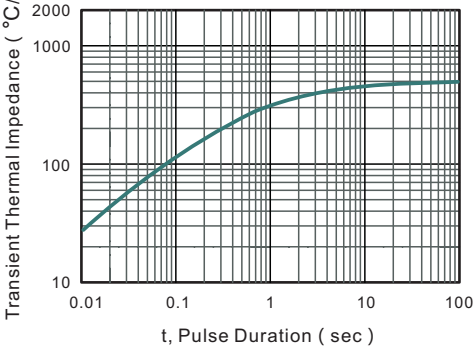

Fig.6 Typical Transient Thermal Impedance



PACKAGE OUTLINE

Plastic surface mounted package; 2 leads

SOD-123

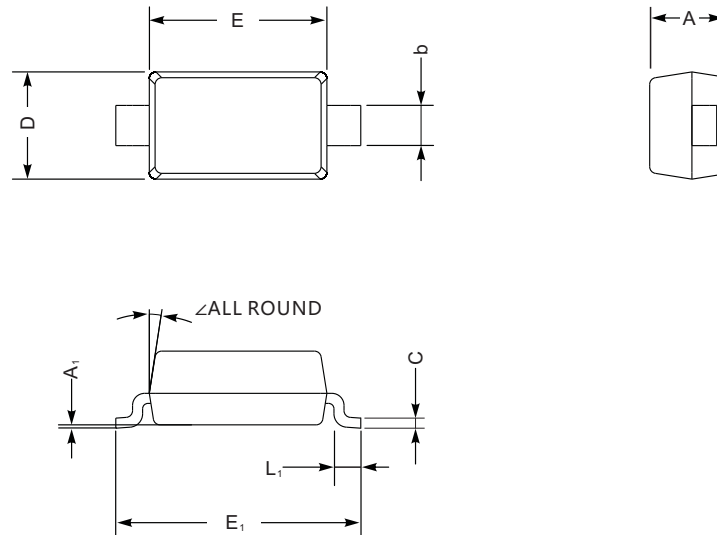

SOD-123 mechanical data

UNIT		A	C	D	E	E ₁	L ₁	b	A ₁	∠
mm	max	1.3	0.22	1.8	2.8	3.9	0.45	0.7	0.2	9°
	min	0.9	0.09	1.5	2.5	3.6	0.25	0.5	—	
mil	max	51	8.7	71	110	154	18	28	8	
	min	35	3.5	59	98	142	10	20	—	

The recommended mounting pad size

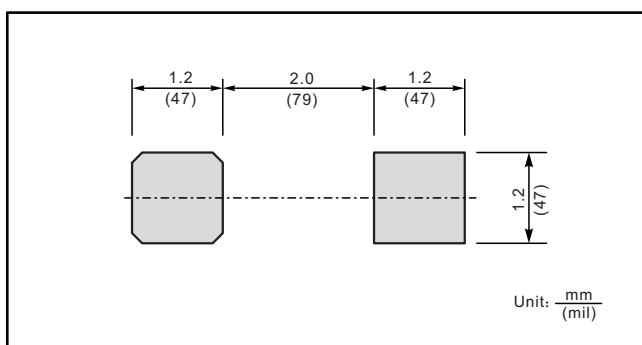

Marking

Type number	Marking code
BAT46W	S9